

CONCRETE SCREW ULTRACUT FBS II 8 -14



Inclined supports



Banisters

VERSIONS

- Zinc-plated steel

BUILDING MATERIALS

Approved for:

- Concrete C20/25 to C50/60, cracked
- Concrete C20/25 to C50/60, non-cracked

Also suitable for:

- Concrete C12/15
- Solid building materials
- Masonry with dense structure

ASSESSMENT/APPROVAL

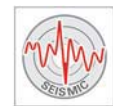

CONCRETE SCREW ULTRACUT FBS II 8 -14

The high-performance concrete screw for easy installation

ADVANTAGES

- Ultracut provides the best possible flexibility in load and fixture thickness with up to three permitted screw-in depths.
- The specialised saw tooth geometry allows it to cut quickly into the concrete.
- No drill hole cleaning is required for mounting in ceilings or floors or when using hollow drill bits with suction.
- The anchoring is free from expansion pressure (undercut), ensuring the lowest possible axial spacing and edge spacing.
- ETA approval covers application in cracked concrete, as well as seismic performance categories C1 and C2.
- Adjustments conforming to the approval makes it possible to loosen the concrete screws 2x, to place materials under and/or align the anchor base plate.
- National approval regulates multiple use for temporary anchoring (e.g. formwork construction).

APPLICATIONS

- Guard rails
- Consoles/base plates
- Metal profiles
- Shelving systems
- Protection barriers
- Results / beam anchors
- Temporary anchoring, e.g. of building site equipment
- Formwork

FUNCTIONING

- The ULTRACUT FBS II is suitable for push-through installation.
- When installing in ceilings and floors, no drill hole cleaning is required. For drill holes in the floor, the user must drill down 3x deeper than the drill hole diameter.
- It is installed using a torque wrench with a socket suited for this type of wrench, or a special Torx bit.

CONCRETE SCREW ULTRACUT FBS II 8 -14

INSTALLATION

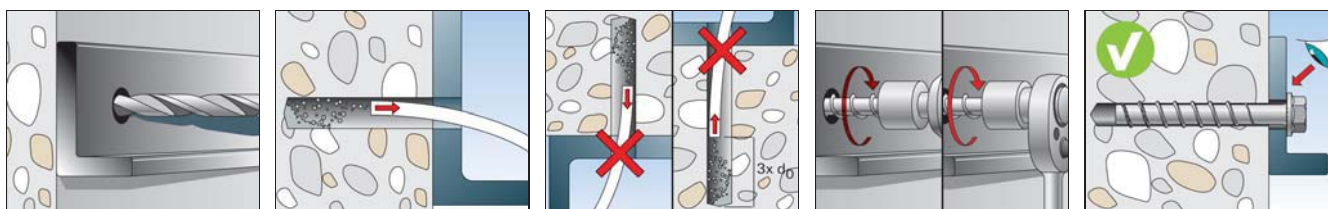

FIXTURE ADJUSTMENT

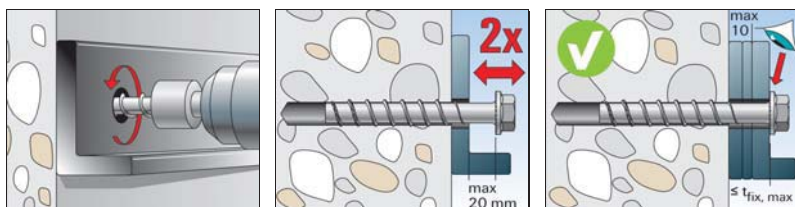

ADDITIONAL FOR SEISMIC

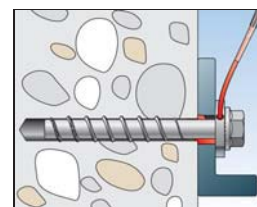

TECHNICAL DATA



ULTRACUT FBS II US - hexagon head with pressed washer

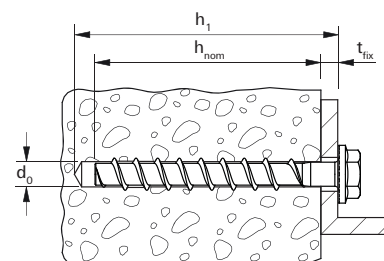

ZINC PLATED

Item	Art.-No.	Approval ETA	Drill hole diameter	Min. drill hole depth for through fixings	Screw	Screw-in depth with fixture thickness	Screw-in depth with fixture thickness	Screw-in depth with fixture thickness	Drive	Sales unit [pcs]
			d ₀ [mm]	h ₁ [mm]	d _a x l _s [mm]	h _{nom1} / t _{fix} [mm]	h _{nom2} / t _{fix} [mm]	h _{nom3} / t _{fix} [mm]		
ULTRACUT FBS II 8x55 5/- US TX	536851	■	8	65	10 x 55	50 / 5	- / -	- / -	TX40/SW13	50
ULTRACUT FBS II 8x70 20/5 US TX	536852	■	8	80	10 x 70	50 / 20	- / -	65 / 5	TX40/SW13	50
ULTRACUT FBS II 8x80 30/15 US TX	536853	■	8	90	10 x 80	50 / 30	- / -	65 / 15	TX40/SW13	50
ULTRACUT FBS II 8x90 40/25 US TX	536854	■	8	100	10 x 90	50 / 40	- / -	65 / 25	TX40/SW13	50
ULTRACUT FBS II 8x100 50/35 US TX	536855	■	8	110	10 x 100	50 / 50	- / -	65 / 35	TX40/SW13	50
ULTRACUT FBS II 8x110 60/45 US TX	536856	■	8	120	10 x 110	50 / 60	- / -	65 / 45	TX40/SW13	50
ULTRACUT FBS II 8x130 80/65 US TX	536857	■	8	140	10 x 130	50 / 80	- / -	65 / 65	TX40/SW13	50
ULTRACUT FBS II 10x60 5/-/- US	536858	■	10	70	12 x 60	55 / 5	- / -	- / -	SW 16	50
ULTRACUT FBS II 10x70 15/5/- US	536859	■	10	80	12 x 70	55 / 15	65 / 5	- / -	SW 16	50
ULTRACUT FBS II 10x80 25/15/- US	536860	■	10	90	12 x 80	55 / 25	65 / 15	- / -	SW 16	50
ULTRACUT FBS II 10x90 35/25/5 US	536861	■	10	100	12 x 90	55 / 35	65 / 25	85 / 5	SW 16	50
ULTRACUT FBS II 10x100 45/35/15 US	536862	■	10	110	12 x 100	55 / 45	65 / 35	85 / 15	SW 16	50
ULTRACUT FBS II 10x120 65/55/35 US	536863	■	10	130	12 x 120	55 / 65	65 / 55	85 / 35	SW 16	50
ULTRACUT FBS II 10x140 85/75/55 US	536864	■	10	150	12 x 140	55 / 85	65 / 75	85 / 55	SW 16	50
ULTRACUT FBS II 10x160 105/95/75 US	536865	■	10	170	12 x 160	55 / 105	65 / 95	85 / 75	SW 16	50
ULTRACUT FBS II 10x200 145/135/115 US	536866	■	10	210	12 x 200	55 / 145	65 / 135	85 / 115	SW 16	20
ULTRACUT FBS II 10x230 175/165/145 US	536867	■	10	240	12 x 230	55 / 175	65 / 165	85 / 145	SW 16	20
ULTRACUT FBS II 10x260 205/195/175 US	536868	■	10	270	12 x 260	55 / 205	65 / 195	85 / 175	SW 16	20
ULTRACUT FBS II 12x70 10/-/- US	536869	■	12	80	14 x 70	60 / 10	- / -	- / -	SW 17	20
ULTRACUT FBS II 12x85 25/10/- US	536870	■	12	95	14 x 85	60 / 25	75 / 10	- / -	SW 17	20
ULTRACUT FBS II 12x110 50/35/10 US	536871	■	12	120	14 x 110	60 / 50	75 / 35	100 / 10	SW 17	20
ULTRACUT FBS II 12x130 70/55/30 US	536872	■	12	140	14 x 130	60 / 70	75 / 55	100 / 30	SW 17	20
ULTRACUT FBS II 12x150 90/75/50 US	536873	■	12	160	14 x 150	60 / 90	75 / 75	100 / 50	SW 17	20
ULTRACUT FBS II 14x75 10/-/- US	536874	■	14	90	16 x 75	65 / 10	- / -	- / -	SW 21	20
ULTRACUT FBS II 14x95 30/10/- US	536875	■	14	110	16 x 95	65 / 30	85 / 10	- / -	SW 21	20
ULTRACUT FBS II 14x100 35/15/- US	536876	■	14	115	16 x 100	65 / 35	85 / 15	- / -	SW 21	20
ULTRACUT FBS II 14x125 60/40/10 US	536877	■	14	140	16 x 125	65 / 60	85 / 40	115 / 10	SW 21	10
ULTRACUT FBS II 14 x 150 85/65/35 US	536878	■	14	165	16 x 150	65 / 85	85 / 65	115 / 35	SW 21	10

CONCRETE SCREW ULTRACUT FBS II 8 -14

TECHNICAL DATA

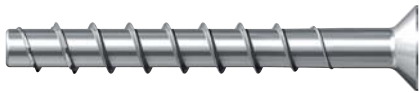

ULTRACUT FBS II CSK countersunk head

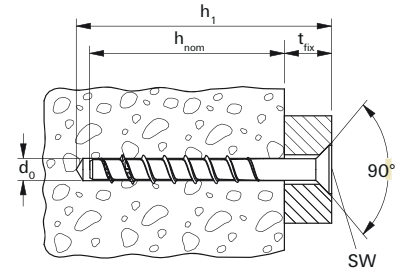

ZINC PLATED

Item	Art.-No.	Approval ETA	Drill hole diameter d ₀ [mm]	Min. drill hole depth for through fixings h ₁ [mm]	Screw d _a x l _s [mm]	Screw-in depth with fixture thickness h _{nom1} / t _{fix} [mm]	Screw-in depth with fixture thickness h _{nom2} / t _{fix} [mm]	Screw-in depth with fixture thickness h _{nom3} / t _{fix} [mm]	Drive	Sales unit [pcs]
ULTRACUT FBS II 8x60 10/- CSK	536880	■	8	70	10 x 60	50 / 10	- / -	- / -	TX40	50
ULTRACUT FBS II 8x80 30/15 CSK	536881	■	8	90	10 x 80	50 / 30	- / -	65 / 15	TX40	50
ULTRACUT FBS II 8x90 40/25 CSK	536882	■	8	100	10 x 90	50 / 40	- / -	65 / 25	TX40	50
ULTRACUT FBS II 10x65 10/-/- CSK	536884	■	10	75	12 x 65	55 / 10	- / -	- / -	TX50	50
ULTRACUT FBS II 10x80 25/15/- CSK	536885	■	10	90	12 x 80	55 / 25	65 / 15	- / -	TX50	50
ULTRACUT FBS II 10x95 40/30/10 CSK	536886	■	10	105	12 x 95	55 / 40	65 / 30	85 / 10	TX50	50
ULTRACUT FBS II 10x100 45/35/15 CSK	536887	■	10	110	12 x 100	55 / 45	65 / 35	85 / 15	TX50	50
ULTRACUT FBS II 10x120 65/55/35 CSK	536888	■	10	130	12 x 120	55 / 65	65 / 55	85 / 35	TX50	50

ACCESSORIES



Checking gauge FUP



Nut SW



Nut TX



FMB T40 Maxx Bit



FPB Profi-bit T50 5/16"

Item	Art.-No.	Internal diameter [mm]	Drive	Product used with	Sales unit [pcs]
Checking gauge FUP 10	537201	12,0	-	FBS II 10	1
Checking gauge FUP 12	537202	13,0	-	FBS II 12	1
Checking gauge FUP 14	537203	15,0	-	FBS II 14	1
Nut SW13	538578	-	1/2" / SW13	FBS II 8	1
Nut SW15	538579	-	1/2" / SW15	FBS II 10	1
Nut SW17	538580	-	1/2" / SW17	FBS II 12	1
Nut SW21	538581	-	1/2" / SW21	FBS II 14	1
Nut TX40	538575 1)	-	1/2" - 1/4"	FBS II 8 / FBS II 8 SK	1
Nut TX50	538576 2)	-	1/2" - 5/16"	FBS II 10 / FBS II 10 SK	1
FMB T40 Maxx Bit	533159	-	TX40	FBS II 8 / FBS II 8 SK	5
FPB Profi-Bit T50 5/16"	538574	-	TX50	FBS II 10 SK	1

1) Suitable for FMB T40 Maxx Bit.

2) Suitable for FPB Profi-Bit T50 5/16".

CONCRETE SCREW ULTRACUT FBS II 8 -14

ACCESSORIES



Filling washer FFD



Washer U

Item	Art.-No.	Internal diameter [mm]	External-Ø d [mm]	Product used with	Sales unit [pcs]
Filling washer FFD 26 x 12 x 6	538458	12,0	26	FBS II 8	4
Filling washer FFD 30 x 14 x 6	538459	14,2	30	FBS II 10 / FBS II 12	4
Filling washer FFD 38 x 19 x 7	538460	19,2	38	FBS II 14	4
Washer for FBS 10	520471	13,5	44	FBS II 10	50

INSTALLATION DATA - CONCRETE C20/25 - C50/60

Type US

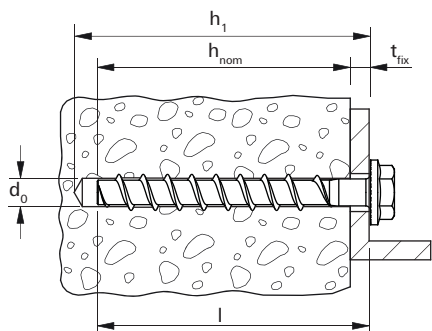

Type SK

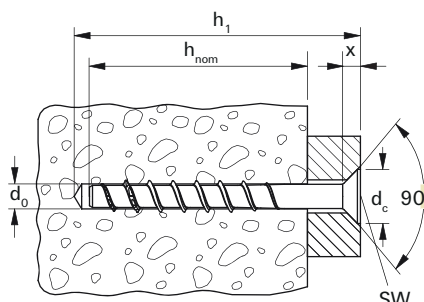

	X [mm]	dc [mm]
ULTRACUT FBS II 8	6	20
ULTRACUT FBS II 10	7	23

ULTRACUT FBS II Concrete screw		8	10	12	14
Drill hole diameter	d0 [mm]	8	10	12	14
Nominal screw-in depth	hnom1 [mm]	50	55	60	65
	hnom2 [mm]	-	65	75	85
	hnom3 [mm]	65	85	100	115
Drill hole depth (push-through installation)	h1 ≥ [mm]	l + 10	l + 10	l + 10	l + 15
Clearance hole diameter	df	10,6 - 12	12,8 - 14	14,8 - 16	16,9 - 18
Max. torque for installation with impact screw driver in concrete	Timp, max	600	650	650	650
Max. torque for manual installation in concrete	Tmax	65	100	150	250
Width across flat	SW	13	15	17	21
Drive	Torx	T40 (SK u. US)	T50 (SK)	-	-

INSTALLATION DATA - MASONRY

ULTRACUT FBS II Concrete screw					
Building material	Compressive strength class [N/mm²]	Size	[mm]	8	10
		hnom	[mm]	65	85
Solid clay brick (EN771-1)	≥ 12	Tinst	[Nm]	5	10
Solid sand-lime brick (EN771-2)	≥ 12	Tinst	[Nm]	15	15
Aerated concrete (EN771-4)	≥ 6	Tinst	[Nm]	5	10



CONCRETE SCREW ULTRACUT FBS II 8 - 14

LOADS

Concrete screw ULTRACUT FBS II

Highest permissible loads for a single anchor¹⁾ in concrete C20/25⁴⁾

For the design the complete assessment ETA-15/0352 has to be considered.

Type	Embedment depth h_{nom} [mm]	Min. member thickness h_{min} [mm]	Installation torque $T_{inst, max}^{5)}$ [Nm]	Cracked concrete				Non-cracked concrete			
				Permissible tensile load $N_{perm}^{3)}$ [kN]	Permissible shear load $V_{perm}^{3)}$ [kN]	Min. spacing $s_{min}^{2)}$ [mm]	Min. edge distance $c_{min}^{2)}$ [mm]	Permissible tensile load $N_{perm}^{3)}$ [kN]	Permissible shear load $V_{perm}^{3)}$ [kN]	Min. spacing $s_{min}^{2)}$ [mm]	Min. edge distance $c_{min}^{2)}$ [mm]
FBS II 8	50	100	≤ 600	2,9	4,2	35	35	5,9	5,9	35	35
	65	120		5,7	9,0	35	35	9,0	9,0	35	35
FBS II 10	55	100	≤ 650	4,3	4,8	40	40	6,8	6,8	40	40
	65	120		5,7	12,5	40	40	8,8	14,0	40	40
	85	140		9,6	16,6	40	40	13,5	16,6	40	40
FBS II 12	60	110		5,5	11,0	50	50	7,7	15,2	50	50
	75	130		8,0	15,2	50	50	11,2	15,2	50	50
	100	150		12,5	20,3	50	50	17,5	20,3	50	50
FBS II 14	65	120		6,1	12,1	60	60	8,5	17,0	60	60
	85	140		9,4	18,8	60	60	13,2	22,1	60	60
	115	180		15,4	29,4	60	60	21,6	29,4	60	60

¹⁾ The partial safety factors for material resistance as regulated in the assessment as well as a partial safety factor for load actions of $\gamma_L = 1,4$ are considered. As a single anchor counts e.g. an anchor with a spacing $s \geq 3 \times h_{ef}$ and an edge distance $c \geq 1,5 \times h_{ef}$.

²⁾ Minimum possible axial spacings resp. edge distance while reducing the permissible load.

³⁾ For combinations of tensile loads, shear loads, bending moments as well as reduced edge distances or spacings (anchor groups) see assessment.

⁴⁾ For higher concrete strength classes up to C50/60 higher permissible loads may be possible.

⁵⁾ Maximum allowable torque moment for installation with any tangential impact screw driver.

LOADS

Concrete screw ULTRACUT FBS II

Highest recommended loads^{1) 3) 4) 5) 6) 7)} for each fixing point in solid brick masonry.

Base material	Compressive strength class [N/mm ²]	Type	FBS II 8		FBS II 10	
			h_{nom} [mm]	[kN]	[mm]	[kN]
Solid clay brick (EN771-1), 240x113x115 mm	≥ 12	Fempf ²⁾	65	1,1	85	1,4
	≥ 20	Fempf ^{2), 8)}		1,6		1,6
Solid sand-lime brick (EN771-2), ≥ 240x71x115 mm	≥ 12	Fempf ^{2), 8)}		1,2		1,2
	≥ 20	Fempf ^{2), 8)}		1,2		1,2
Aerated concrete (EN771-4), ≥ 499x100x100 mm	≥ 6	Fempf ²⁾		0,7		0,9
Minimum spacing within anchor groups of 2 or 4 anchors		s_{min}				80
Minimum distance to the horizontal joint		$c_{min,v}$				20
Minimum distance to the vertical joint		$c_{min,h}$				40
Minimum distance to the free edge		$c_{min,free}$				200

¹⁾ An appropriate safety factor is considered.

²⁾ The given loads apply to the given brick measures. For bigger sizes higher recommended loads may be possible. In this case please contact our technical department for further advice.

³⁾ Valid for tensile load, shear load and oblique load under any angle.

⁴⁾ On-site screw testing is recommended to validate technical data. If the joints are not visible 100% anchor testing is recommended due to the screws are only working in the bricks and not in the mortar joints.

⁵⁾ The given data are valid for multiple fixings of non-structural applications.

⁶⁾ A fixing point can be a single anchor, 2 anchors or 4 anchors with a minimum spacing s_{min} . Anchor groups of 4 anchors are arranged in rectangular disposition.

⁷⁾ The fixing points have to be arranged in this way that there will be always maximum one fixing point arranged in one brick.

⁸⁾ Brick pull-out is decisive.

INSTALLATION DATA - TEMPORARY FIXING

Drill hole diameter d_0 / screw diameter	[mm]	8		10			12			14		
		50	65	55	65	85	60	75	100	65	85	115
Nominal anchoring depth [h_{nom}]	[mm]	50	65	55	65	85	60	75	100	65	85	115
Permissible Loads $N_{perm}^{3)}$ for cracked and non-cracked concrete												
Concrete strength $f_{ck,cube} \geq 10N/mm^2$	[kN]	1,9	3,6	2,2	2,9	5,8	2,8	4,0	7,6	2,3	3,6	8,9
Concrete strength $f_{ck,cube} \geq 15N/mm^2$	[kN]	2,3	4,4	2,7	3,5	7,1	3,4	4,9	9,3	2,8	4,4	10,8
Concrete strength $f_{ck,cube} \geq 20N/mm^2$	[kN]	2,6	5,1	3,1	4,1	8,1	3,9	5,6	10,8	3,2	5,0	12,6
Concrete strength $f_{ck,cube} \geq 25N/mm^2$	[kN]	2,9	5,6	3,5	4,5	9,1	4,4	6,1	12,0	3,6	5,6	14,0
Minimum concrete member thickness	[mm]	100	150	105	130	205	120	150	240	115	150	255
Minimum spacing ²⁾	[mm]	200	300	310	260	410	240	300	180	230	300	510
Minimum edge distance in load direction ²⁾	[mm]	65	100	70	85	135	80	100	160	75	100	170
Minimum edge distance rectangular to load direction ²⁾	[mm]	100	150	105	130	205	120	150	240	115	150	255
Torque moment with impact screw driver	$T_{imp, max}$	400	400	400	400	650	400	400	650	400	400	650
Torque moment with standard torque wrench	T_{max}	45	65	65	65	100	75	75	150	75	75	150

¹⁾ The partial safety factor for load actions of $\gamma_L = 1,4$ is considered.

²⁾ Minimum spacing and edge distance for single anchors.

³⁾ Valid for tensile load, shear load and oblique load under any angle. Exception: perpendicular to the axis of tilt-up brace acting forces.

⁴⁾ E.g. tilt-up braces, fall protections and scaffoldings.



CONCRETE SCREW ULTRACUT FBS II 8 - 12 A4



Handrail anchors

e.g. ULTRACUT FBS II 10x120 35/- US A4



Cantilevers / Base plates

e.g. ULTRACUT FBS II 12x110 10/- US A4



Canopies

e.g. ULTRACUT FBS II 12x130 30/- US A4



Stadium seating anchor

e.g. ULTRACUT FBS II 10x120 35/- US A4

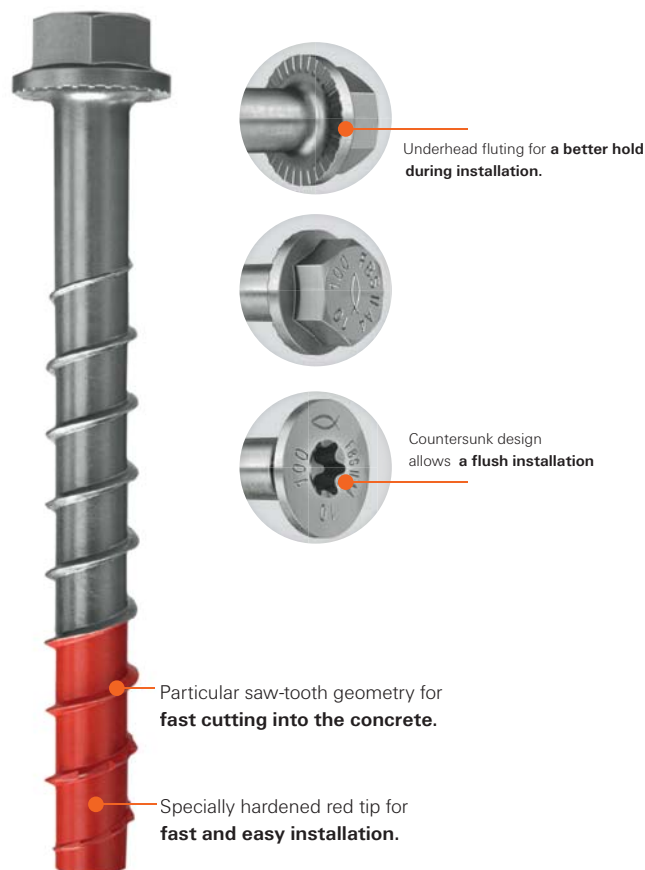

ASSESSMENT/APPROVAL

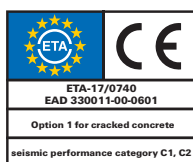

CONCRETE SCREW ULTRACUT FBS II 8 - 12 A4

The high-performance concrete screw for metal construction and external applications

ADVANTAGES

- The specially hardened red tip provides a faster and more secure installation.
- The stainless steel concrete screw guarantees a high level of corrosion resistance especially for wet rooms and external applications.
- The ETA approval covers applications in cracked concrete, as well as seismic performance categories C1 and C2.
- The concrete screw ULTRACUT FBS II A4 offers the possibility for usage in masonry (solid building material).

APPLICATIONS

- Maximum loads and minimum edge/axial spacing in cracked concrete, e.g. railings
- Maximum loads in cracked and non-cracked concrete in wet conditions, e.g. brackets/base plates
- Anchoring in wet conditions, e.g. canopies
- Outdoor stadium seating anchoring
- Secure and corrosion resistant applications, e.g. balcony railings
- Column footing
- For diamond drilled drill holes

FUNCTIONING

- The ULTRACUT FBS II A4 is designed for push-through installation.
- It is recommended to use an impact wrench with a suitable impact socket or torx bit.
- Drill holes do not need to be cleaned during vertical installation (ceiling and floor) or when using a hollow drill. For floor fixing the hole must be drilled 3x dØ deeper.
- The screw is installed correctly when the screw head sits flush and no manual rotation of the screw is possible (hand and visual check).



CONCRETE SCREW ULTRACUT FBS II 8 - 12 A4

INSTALLATION

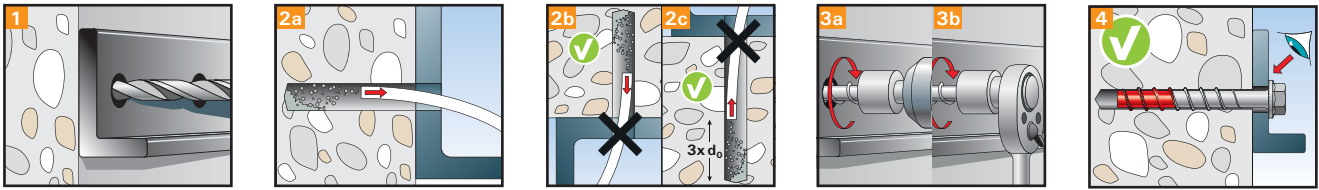

FIXTURE ADJUSTMENT in accordance with the approval requirements

ADDITIONAL FOR SEISMIC



ULTRACUT FBS II 8 - 12 A4 - US - hexagonal screw



ULTRACUT FBS II 8 - 12 A4 - SK - countersunk head

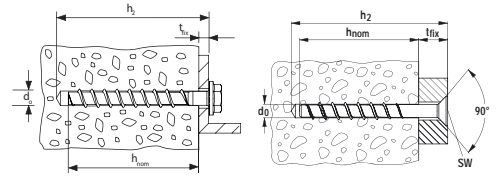

Concrete Screws ULTRACUT FBS II A4

Item	Art.-No.	Approval	Nominal drill-Ø	Minimum drill depth at push-through mode	Anchor length	Screwing depth						Width across flat / internal torx drive	Sales unit
						h _{nom, 1}	t _{fix 1}	h _{nom, 2}	t _{fix 2}	h _{nom, 3}	t _{fix 3}		
	A4	ETA	d ₀ [mm]	h ₂ [mm]	l [mm]	[mm]	[mm]	[mm]	[mm]	[mm]	[mm]	[SW/TX]	[pcs]
FBS II 8x60 10/- US A4	543565	■	8	70	60	50	10	-	-	-	-	13	50
FBS II 8x70 20/5 US A4	543566	■	8	80	70	50	20	-	-	65	5	13	50
FBS II 8x80 30/15 US A4	543567	■	8	90	80	50	30	-	-	65	15	13	50
FBS II 8x90 40/25 US A4	543568	■	8	100	90	50	40	-	-	65	25	13	50
FBS II 10x60 5/- US A4	543569	■	10	70	60	55	5	-	-	-	-	15	50
FBS II 10x70 15/5/- US A4	543570	■	10	80	70	55	15	65	5	-	-	15	50
FBS II 10x80 25/15/- US A4	543571	■	10	90	80	55	25	65	15	-	-	15	50
FBS II 10x90 35/25/5 US A4	543572	■	10	100	90	55	35	65	25	85	5	15	50
FBS II 10x100 45/35/15 US A4	543573	■	10	110	100	55	45	65	35	85	15	15	50
FBS II 10x120 65/55/35 US A4	543574	■	10	130	120	55	65	65	55	85	35	15	50
FBS II 12x70 10/- US A4	543575	■	12	80	70	60	10	-	-	-	-	17	20
FBS II 12x85 25/10/- US A4	543576	■	12	95	85	60	25	75	10	-	-	17	20
FBS II 12x110 50/35/10 US A4	543577	■	12	120	110	60	50	75	35	100	10	17	20
FBS II 12x130 70/55/30 US A4	543578	■	12	140	130	60	70	75	55	100	30	17	20
FBS II 8x60 10/- SK A4	543579	■	8	70	60	50	10	-	-	-	-	T40	50
FBS II 8x80 30/15 SK A4	543580	■	8	90	80	50	30	-	-	65	15	T40	50
FBS II 8x90 40/25 SK A4	543581	■	8	100	90	50	40	-	-	65	25	T40	50
FBS II 10x65 10/- SK A4	543582	■	10	75	65	55	10	-	-	-	-	T50	50
FBS II 10x80 25/15/- SK A4	543583	■	10	90	80	55	25	65	15	-	-	T50	50
FBS II 10x95 40/30/10 SK A4	543584	■	10	105	95	55	40	65	30	85	10	T50	50
FBS II 10x100 45/35/15 SK A4	543585	■	10	110	100	55	45	65	35	85	15	T50	50
FBS II 10x120 65/55/35 SK A4	543586	■	10	130	120	55	65	65	55	85	35	T50	50

